

## Rotating Hemostasis Valves

### Y-Connector

1. Guidewire or catheter required for vascular intervention of insertion and easy hemostasis
2. Using of 5Fr ~ 9Fr can be selected depending on the purpose of the procedure

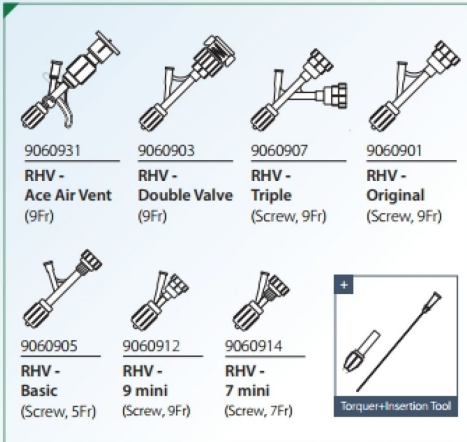

## Synergy Aspirator

### Thrombus Suction System

1. Easy to remove Thrombus in blood vessels during vascular intervention
2. Can be used in connection with all kinds of catheters and other medical devices
3. Looking at the vacuum pressure meter, immediately know the thrombus was removed.

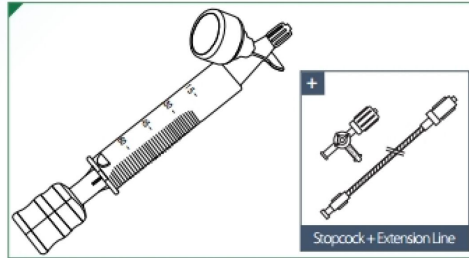

### Control Syringe

#### Ring plunger & Ring grip with rotating male luer adaptor

1. Used to inhale medicines, etc.
2. Easy connection of other medicines and medical devices
3. Special purpose syringes can be produced to order.

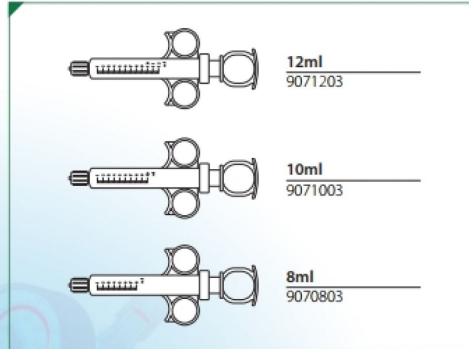

## Manifolds

### Apparatus for non-implantable type vascular connection

1. Linking tool used with products to be linked during interventional procedures
2. On or Off type can be selected according to the usage environment.

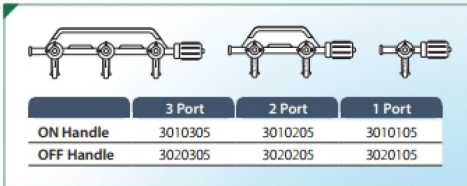

## Extension Line

### Direct Injection Medication Equipment

1. Used as extension connector for drug injection
2. Having the various sizes required for the Surgical procedure
3. Special purpose line can be produced to order.



will continue to develop medical devices that maximize the safety and convenience of doctors for human health and happiness.

# ACE AIR VENT

Rotating Hemostasis Valve

Y-CONNECTOR ANGLE  
- The most useful angle implementation

AIR VENT BUTTON  
- Easily removed air bubble during procedure

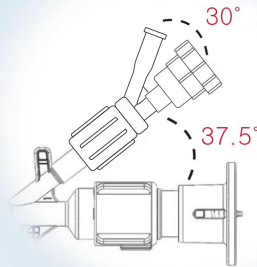
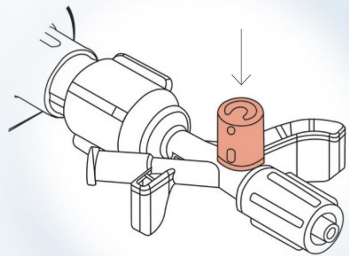

HOW TO GRIP  
- Stable position with 3 points

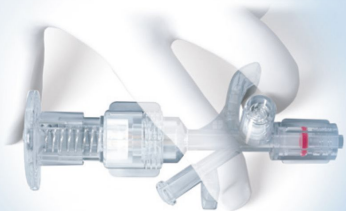

2<sup>nd</sup> INDIVIDUAL VALVE  
- It never twist catheter etc.

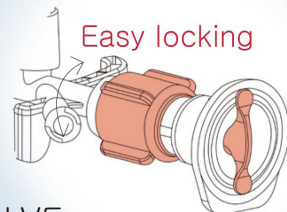
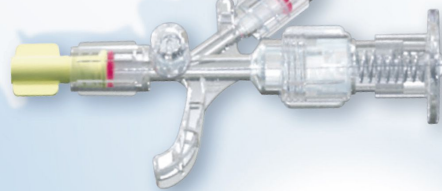

# SYNERGY ASPIRATOR

Thrombus Suction System

QUICKLY PREPARE TO THE EMERGENCY PATIENT

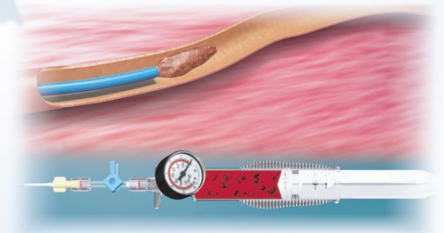

LUER  
It can use every catheter

VACUUM PRESSURE METER  
Immediately know the thrombus was removed

LOCKING SYSTEM  
3 points of locking system  
15, 45, 60cc

EASY TO HANDLE BY MANUAL

DIVIDER  
- It can divide the entrance  
2way right and left

